







Model	PL8HM	PL8HE	PL8NT
IEC/EN 61009-1			
Poles	1P+N	1P+N	1P+N
Certification			
Electrical Specification			
Rated current(A)	I_n 6-32	6-32	6-32
Rated frequency(Hz)	50/60	50/60	50/60
Rated working voltage(V)	U_e 230	230	230
Rated insulated voltage(V)	U_i 400	400	400
Rated impulse withstand voltage(kV)	U_{imp} 4	4	4
Rated short-circuit breaking capacity(KA)	I_{cs} 6	6	4.5
Rated Residual current(mA)	$I_{\Delta n}$ 30,100,300	30,100,300	30,100,300
Thermo-magnetic release characteristic	B,C,D	B,C,D	B,C
Residual current protection type	Electromagnetic	Electronic	Electronic
Residual current working type	A,AC	A,AC	A,AC
Rated residual making and breaking capacity(A) $I_m/I_{\Delta m}$	500	500	500
Dielectric test voltage(kV)	2.5		
Service life (O-C)	Mechanical Standard value	4000	4000
	Electrical Standard value	2000	2000
Control And Indication			
Shunt release(SHT)		■	
Undervoltage release(UVT)		■	
Auxiliary contact(AUX)		■	
Alarm contact(ALT)		■	
Contact position indicator		■	
Fault indication		-	
Connection And Installation			
Ambient temperature(with daily average $\leq 35^\circ\text{C}$)	-5 $^\circ\text{C}$ ~+40 $^\circ\text{C}$		
Protection degree	ALL sides	IP40	
	Connection terminal	IP20	
Wire(mm ²)	1-16	1-16	1-6
busbar(mm ²)	16	16	-
Mounting	Cable/Busbar	Cable/Busbar	Cable
Pollution degree	2		
Reference temperature for setting of thermal element($^\circ\text{C}$)	30		
Storage temperature($^\circ\text{C}$)	-25 $^\circ\text{C}$ ~+70 $^\circ\text{C}$		
Tightening torque	3.0	3.0	2.0
Connection	Top and bottom	Top	Top
Dimensions(mm) (WxHxL)	a(2P)	35.7	17.7
	b(2P)	87	87
	c(2P)	77.5	77.5
Weight(kg)	2P	0.18	0.11

■ Default □ Optional - None

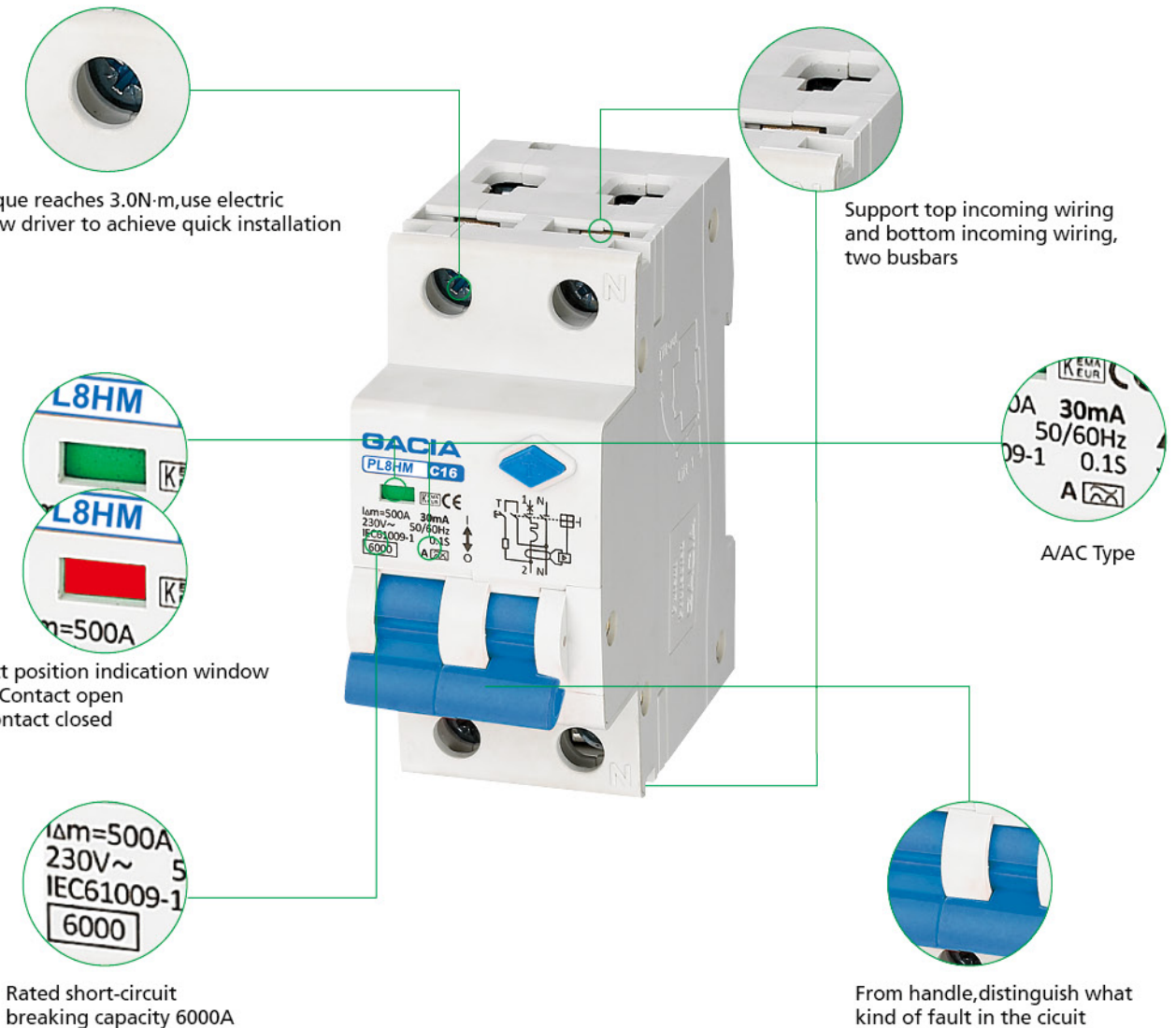

Normal Working Conditions and Installation Conditions

- ◆ Ambient Temperature: -5 $^\circ\text{C}$ ~+40 $^\circ\text{C}$.
- ◆ Height above Sea Level: $\leq 2000\text{m}$
- ◆ Installation Category: II, III
- ◆ Pollution Degree: 2
- ◆ The installation type adopts standard steel guide rail installation (TH35-7.5).
- ◆ Installation Conditions: The external magnetic field of the installation site shall not exceed 5 times of the earth's magnetic field in any direction. When over voltage residual current moves, the circuit breaker shall be installed vertically, and the upward position of the handle shall be connected to the power. The installation should be free from obvious impact and vibration.
- ◆ Mode of Connection: Use screws to press the wiring.

Characteristics Curve

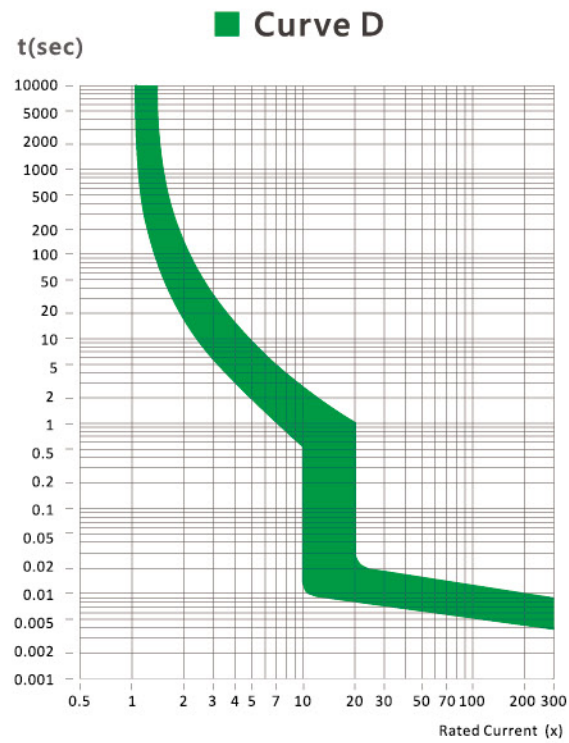
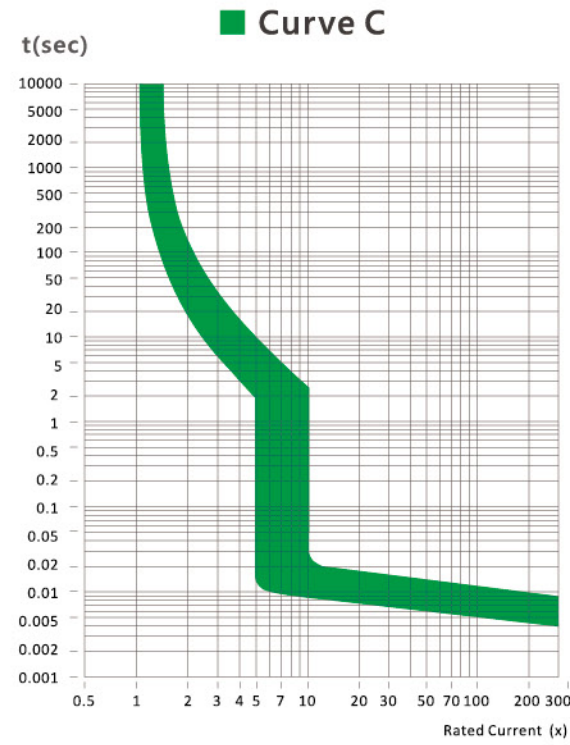
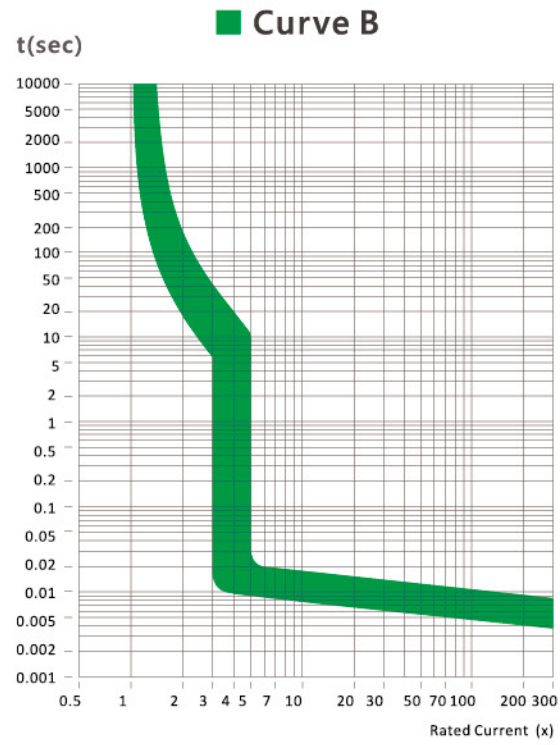





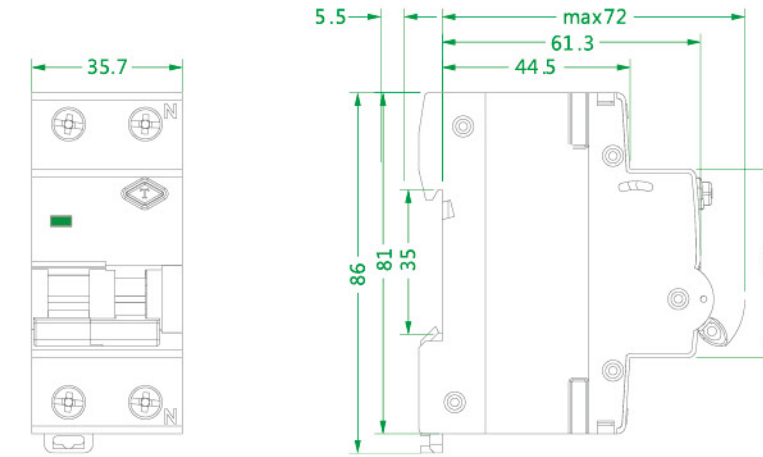

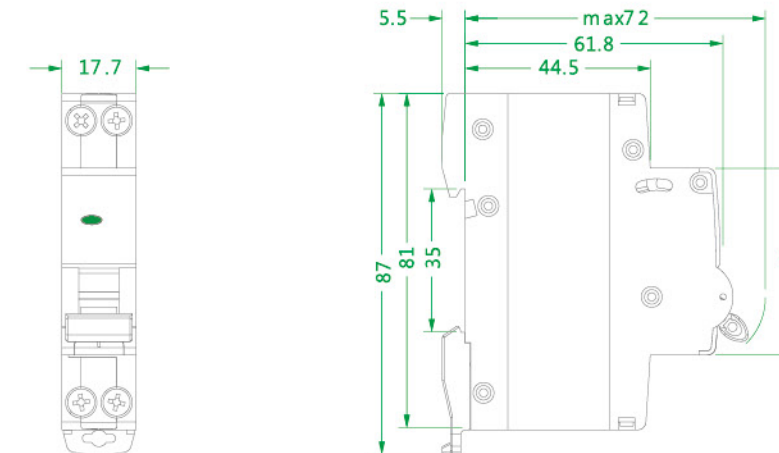

Dimensions

◆ PL8HM/PL8HE



◆ PL8NT



Model		PR8NM	PR8HM	PR8NE	PR8HE
IEC/EN 61008-1					
Poles		2P,4P	2P,4P	2P,4P	2P,4P
Certification					
Electrical Specification					
Rated current(A)	In	16-100A	16-100A	16-100A	16-100A
Rated working voltage(V)	ue	2P:230,4P:400	2P:230,4P:400	2P:230,4P:400	2P:230,4P:400
Rated insulated voltage(V)	ui	500	500	500	500
Impulse withstand voltage(kV)	uimp	6	6	6	6
Rated conditional short-circuit current(kA)	I _{nc}	6	10	6	10
Rated Residual current(mA)	I _{Δn}	10,30,100,300	10,30,100,300	10,30,100,300	10,30,100,300
Rated Residual making and breaking capacity(A)	I _{Δm}	1000	1000	1000	1000
Residual current working type		AC,AC+S,A,A+S	AC,AC+S,A,A+S	AC,AC+S,A	AC,AC+S,A
Residual current Protection type		Electromagnetic	Electromagnetic	Electronic	Electronic
Dielectric test voltage(kV)		2.5			
Service life (O-C)	Mechanical Standard value	4000			
	Electrical Standard value	2000			
Control And Indication					
Shunt release(SHT)		-			
Undervoltage release(UVT)		-			
Auxiliary contact(AUX)		-			
Alarm contact(ALT)		-			
Contact position indicator		-			
Fault indication		□			
Connection And Installation					
Ambient temperature(with daily average≤35℃)		-5℃ ~+40℃			
Protection degree	ALL sides	IP40			
	Connection terminal	IP20			
Wire(mm ²)		35			
busbar(mm ²)		35			
Mounting		Cable/Busbar			
Pollution degree		30			
Reference temperature for setting of thermal element(℃)		2			
Storage temperature(℃)		-25℃ ~+70℃			
Tightening torque		Top and bottom	Top and bottom	Top	Top
Connection		36/72			
Dimensions(mm) (WxHxL)	a(2P)	87/87			
	b(2P)	79.5/79.5			
	c(2P)	0.17			
Weight(kg)		2P	0.34		

■ Default □ Optional - None

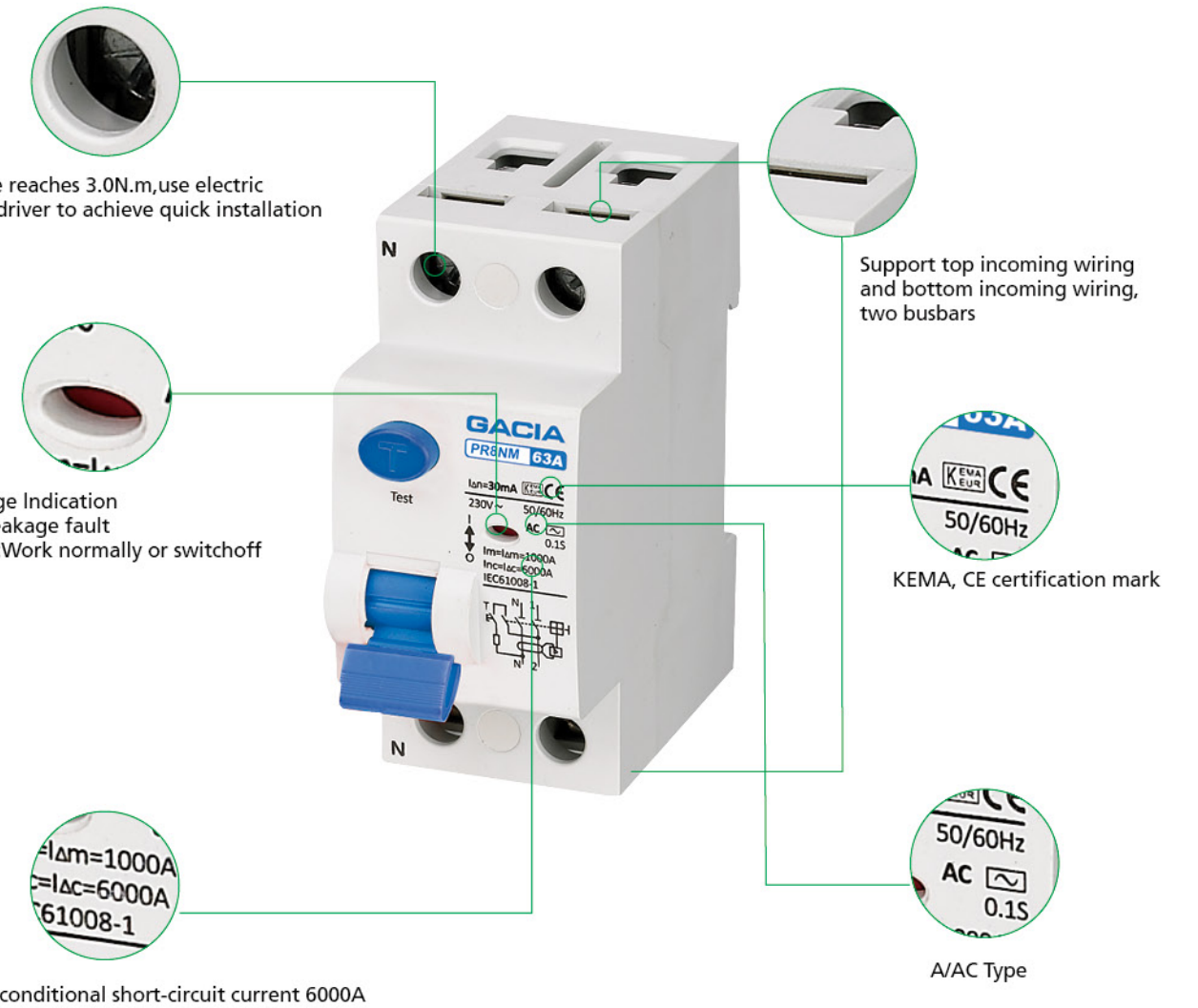

Normal Working Conditions and Installation Conditions

- ◆ Ambient Temperature: -5℃ ~+40℃ .
- ◆ Height above Sea Level: ≤ 2000m
- ◆ Installation Category: II, III
- ◆ Pollution Degree: 2
- ◆ The installation type adopts standard steel guide rail installation (TH35-7.5).
- ◆ Installation Conditions: The external magnetic field of the installation site shall not exceed 5 times of the earth's magnetic field in any direction. When over voltage residual current moves, the circuit breaker shall be installed vertically, and the upward position of the handle shall be connected to the power. The installation should be free from obvious impact and vibration.
- ◆ Mode of Connection: Use screws to press the wiring.

Dimensions

◆ PR8NM/PR8HM/PR8NE/PR8HE

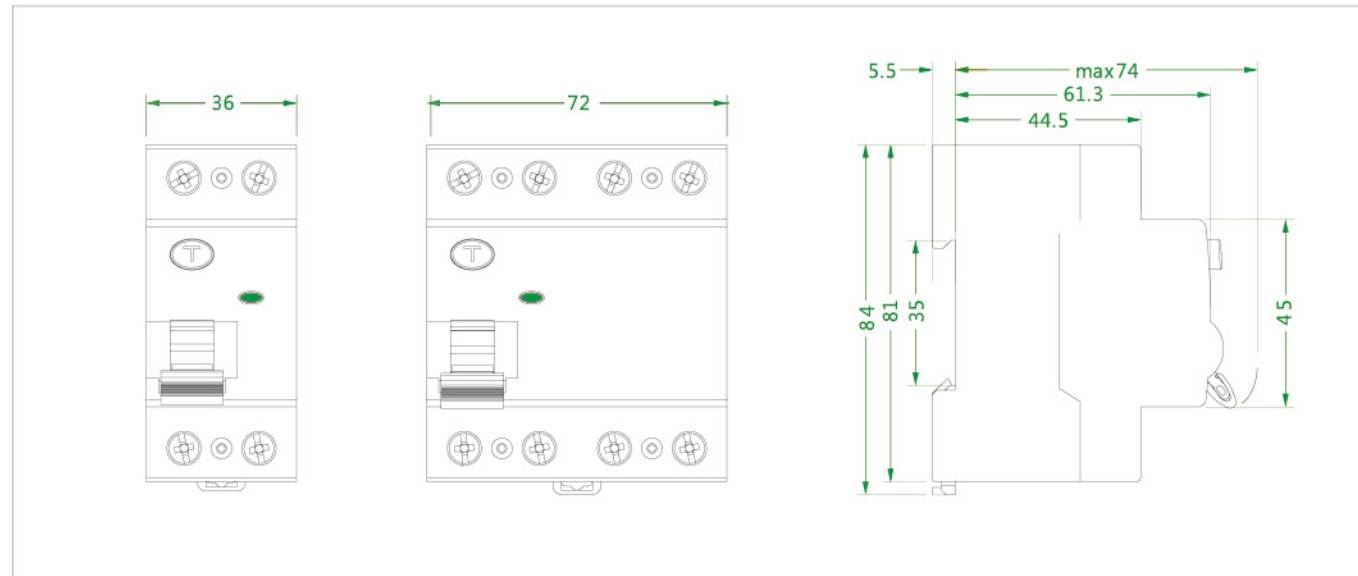

The combination of electrical accessory devices.

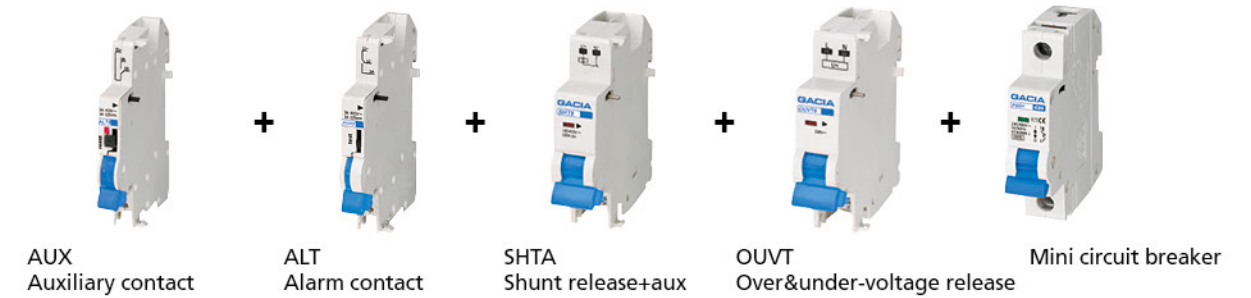

Remote indicating accessories

AUX auxiliary contact

Function: indicate the open and close state of circuit breaker.
Application: distant indication of circuit breaker state.

ALT Alarming contact

Function: send signal at the time of fault tripping of circuit breaker.
On the front panel, there is mechanical indication which can indicate fault tripping.

AUX+ALT/AUX double switching contact

Function: two switching contact can indicate the "open" or "closed" state of circuit breaker with OFF. Indicate the failure trip of circuit breaker.
Application: two loops Up :AUX
Down: ALT and AUX
Select functions with the rotating switch on the right.
Selecting function indicated on the front cover of the device.
Be a red indicator on the front cover of the device when failure trips.

Tripping accessories

Red tripping indicator on the front cover of the device.

SHT shunt release, SHTA shunt release+aux

Function: when it gets signal, it triggers the circuit breaker to trip.
SHTA: it includes a condition indication contact to indicate the on/off state of circuit breakers.
Application: distant control can achieve emergency breaking.
Distant indication of circuit breaker state.

UVT under-voltage release

Function: when power voltage lowers(35%~70%Un), it makes circuit breaker trip; when power is not supplied normally, it prevents circuit breaker from reconnecting to the circuit.
0.25 time delay prevents the temporary lowering of voltage from causing mistrip.
Application: preventing machine from restarting without control signal, ensuring safety.

OVT over-voltage release

Function: monitor voltage between phase line and neutral line. When voltage rises(for example, neutral line is broken), it triggers circuit breakers to trip.
Rated tripping voltage range: 280vac +/-5%.
Application: preventing over-voltage from damaging circuit and equipment.

OUVT Over&under-voltage release

Function: it has function of over-voltage release, and function of making circuit breaker trip when power voltage lowers.
Rated tripping voltage range: 280vac +/-5%.
Rated under-voltage tripping range: 55 ~160v.
Application: preventing over-voltage and under-voltage from damaging circuit and equipment.